

G5 Lampholders, Accessories

For fluorescent lamps T5 (T16)

Max. permitted temperature T_m
on the rear side of the lampholder: 110 °C

G5 pushthrough/surface-mounted lampholder
Lamp axis push-through lampholder: 13.2 mm
Lamp axis surface-mounted lampholder: 15.2 mm
Casing: PC, white, T110
Nominal rating: 2/500
Push-in terminals: 0.5–1 mm²
Lateral fixing clips for wall thickness 0.5–1.5 mm
Fixing slot for screw M3
Weight: 3.2 g, unit: 1000 pcs.
Type: 09105

Ref. No.: 100305

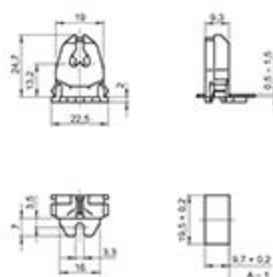

G5 built-in lampholder
Casing: PC, white, T110
Nominal rating: 2/500
Push-in terminals: 0.5–1 mm²
Rear split pins for wall thickness up to 1.2 mm
Weight: 2.6 g, unit: 1000 pcs.
Type: 09205

Ref. No.: 100310

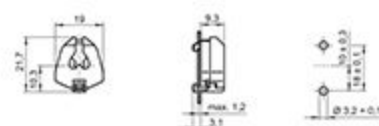

G5 built-in/push-fit lampholder
Lamp axis: 12 mm
Casing: PC, white, T110
Nominal rating: 2/500
Push-in terminals: 0.5–1 mm²
Rear split pins for wall thickness up to 1.2 mm
Base split pins for wall thickness up to 1 mm
Weight: 2.9 g, unit: 1000 pcs.
Type: 09210

Ref. No.: 106455

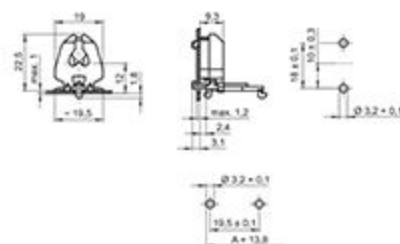

G5 pushthrough lampholders
For the automatic luminaire wiring
Casing: PBT GF, white, frontplate: PC, white
Rotor: PBT GF, white, T140, lamp axis: 15 mm
Nominal rating: 2/500
IDC terminals for leads H05V-U 0.5
Lateral fixing clips for wall thickness 0.5–1.5 mm
Weight: 5 g, unit: 1000 pcs.
Type: 09420/ 09421

Ref. No.: 532377 with stop

Ref. No.: 532378 without stop

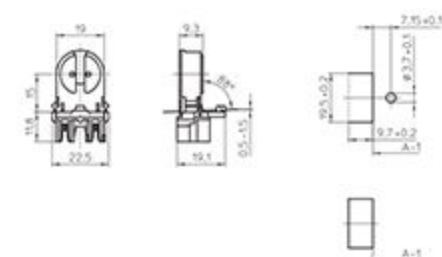

Lampholders and Accessories for T Lamps

G5 push-fit lampholder

For the automatic luminaire wiring

Lamp axis: 18 mm

Casing: PC, white, rotor: PBT GF, white, T130

Nominal rating: 2/500

IDC terminals for leads H05V-U 0.5

Lateral push-in twin terminals: 0.5–1 mm²

Weight: 5.5 g, unit: 1000 pcs.

Type: 09900

Ref. No.: 534644

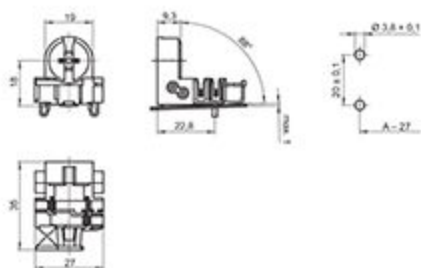

1

2

G5 built-in lampholder

Casing: PBT GF, white, rotor: PBT GF, white

T140, nominal rating: 2/500

Push-in twin terminals: 0.5–1 mm²

Lateral fixing clips

Weight: 2.8 g, unit: 1000 pcs.

Type: 09404

Ref. No.: 505732



3

4

G5 built-in lampholders

Casing: PBT GF, white, rotor: PBT GF, white

T140, nominal rating: 2/500

Push-in twin terminals: 0.5–1 mm²

Rear split pins for wall thickness up to 1.2 mm

Weight: 2.9/3.3 g, unit: 1000 pcs.

Type: 09405

Ref. No.: 505733

Type: 09406 with spring adjustment

Ref. No.: 505734

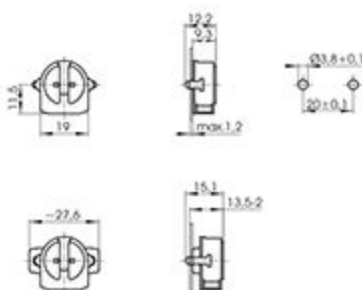

5

6

G5 built-in lampholder

Lampholder thickness: 12.5 mm

Casing: PBT GF, white, rotor: PBT GF, white

T140, nominal rating: 2/500

Push-in twin terminals: 0.5–1 mm²

Rear split pins for wall thickness up to 1 mm

Weight: 3 g, unit: 1000 pcs.

Type: 09407

Ref. No.: 508590

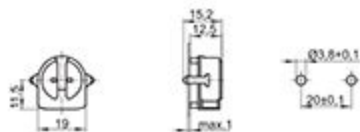

7

8

G5 built-in lampholders

Casing: PBT GF, white, rotor: PBT GF, white

T140, nominal rating: 2/500

Push-in twin terminals: 0.5–1 mm²

Rear split pins for wall thickness up to 1.2 mm

Weight: 2.9/3.2 g, unit: 1000 pcs.

Type: 09415

Ref. No.: 505735

Type: 09416 with spring adjustment

Ref. No.: 505736

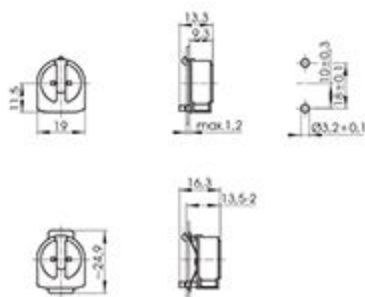

9

10

Lampholders and Accessories for T Lamps

G5 push-through lampholders

Lamp axis: 15 mm

Casing: PBT GF, white, rotor: PBT GF, white

T140, nominal rating: 2/500

Push-in twin terminals: 0.5–1 mm²

Lateral fixing clips for wall thickness 0.5–1.5 mm

Weight: 3.5/3.4 g, unit: 1000 pcs.

Type: 09420/09421

Ref. No.: 505737 with stop

Ref. No.: 505739 without stop

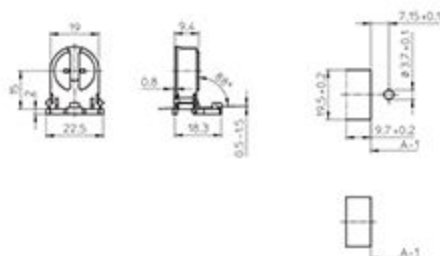

G5 push-through lampholders

Lamp axis: 20 mm

Casing: PBT GF, white, rotor: PBT GF, white

T140, nominal rating: 2/500

Push-in twin terminals: 0.5–1 mm²

Lateral fixing clips for wall thickness 0.5–1.5 mm

Weight: 4.1 g, unit: 1000 pcs.

Type: 09432/09433

Ref. No.: 545933 with stop

Ref. No.: 545935 without stop

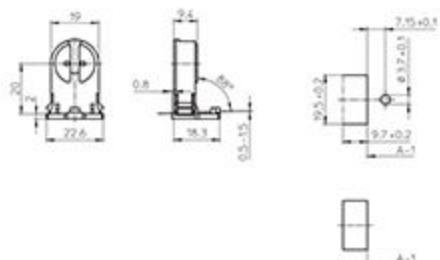

G5 push-through lampholders

Lamp axis: 25 mm

Casing: PBT GF, white, rotor: PBT GF, white

T140, nominal rating: 2/500

Push-in twin terminals: 0.5–1 mm²

Lateral fixing clips for wall thickness 0.5–1.5 mm

Weight: 4.5 g, unit: 1000 pcs.

Type: 09434/09435

Ref. No.: 545937 with stop

Ref. No.: 545939 without stop

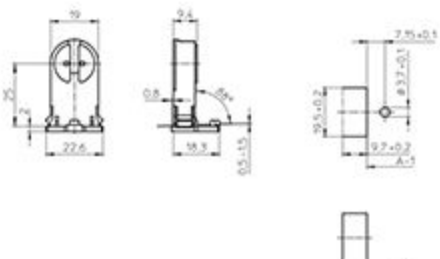

G5 push-through lampholders

Lamp axis: 35 mm

Casing: PBT GF, white, rotor: PBT GF, white

T140, nominal rating: 2/500

Push-in twin terminals: 0.5–1 mm²

Lateral fixing clips for wall thickness 0.5–1.5 mm

Weight: 4.6 g, unit: 1000 pcs.

Type: 09426/09427

Ref. No.: 505745 with stop

Ref. No.: 505746 without stop

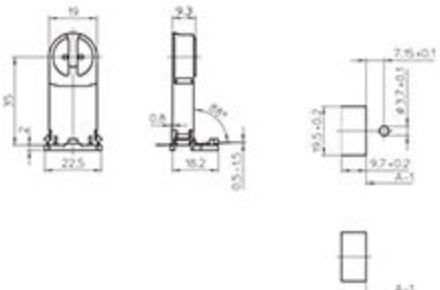

G5 push-fit lampholder

Lamp axis: 14 mm

Casing: PBT GF, white, rotor: PBT GF, white

T140, nominal rating: 2/500

Push-in twin terminals: 0.5–1 mm²

Rear fixing clips for wall thickness 0.6–1 mm

Base or lateral wiring

Weight: 3.3 g, unit: 1000 pcs.

Type: 09440

Ref. No.: 505747

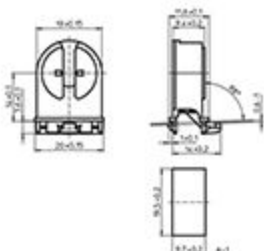

Lampholders and Accessories for T Lamps

G5 push-fit lampholder

Lamp axis: 18 mm

Casing: PBT GF, white, rotor: PBT GF, white

T140, nominal rating: 2/500

Push-in twin terminals: 0.5–1 mm²

Rear fixing clips for wall thickness 0.6–1 mm

Base or lateral wiring

Weight: 3.9 g, unit: 1000 pcs.

Type: 09446

Ref. No.: 545894

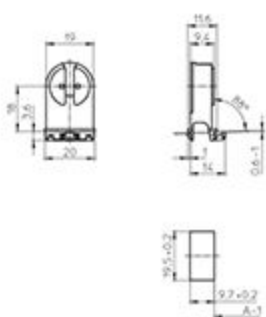

1

2

G5 push-fit lampholder

Lamp axis: 23 mm

Casing: PBT GF, white, rotor: PBT GF, white

T140, nominal rating: 2/500

Push-in twin terminals: 0.5–1 mm²

Rear fixing clips for wall thickness 0.6–1 mm

Base or lateral wiring

Weight: 4.2 g, unit: 1000 pcs.

Type: 09447

Ref. No.: 545896

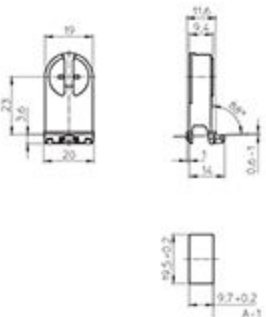

3

4

G5 push-fit lampholder

Lamp axis: 15 mm

Casing: PBT GF, white, rotor: PBT GF, white

T140, nominal rating: 2/500

Push-in twin terminals: 0.5–1 mm²

Base split pins for wall thickness 0.6–1 mm

Weight: 3.4 g, unit: 1000 pcs.

Type: 09450

Ref. No.: 505750

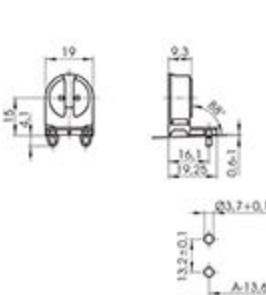

5

6

G5 push-fit lampholder

Lamp axis: 11.8 mm

Casing: PBT GF, white, rotor: PBT GF, white

T140, nominal rating: 2/500

Push-in twin terminals: 0.5–1 mm²

Base split pins for wall thickness up to 1 mm

Lateral wiring

Weight: 3.1 g, unit: 1000 pcs.

Type: 09460

Ref. No.: 505751

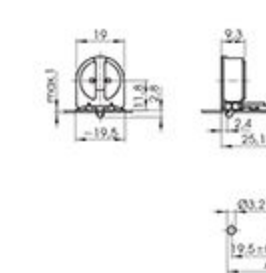

7

8

G5 lampholder

For push-fit onto the lamp

Casing: PBT GF, white, T130

Nominal rating: 2/500

Push-in twin terminals: 0.5–1 mm²

Pin support for reliable contact

Lamp support 109685 (see page 178)

Weight: 3.7 g, unit: 1000 pcs.

Type: 09170

Ref. No.: 109686

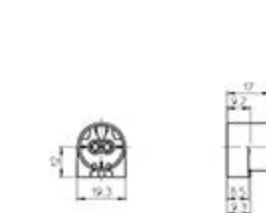

9

10

G5 Lampholders, Degree of Protection IP54/IP65/IP67

For fluorescent lamps T5 (T16)

For luminaires of protection class I and II

Lampholders protected against dust and splashing water (IP54)

Lampholders protected against dust and jet of water (IP65)

Dust and watertight lampholders (IP67)

G5 push-fit lampholder for metal casing
Casing: PC, white, interior part: PBT GF T140, nominal rating: 2/500
Push-in twin terminals: 0.5–1 mm²
Push-fit foot for wall thickness: 1.4–2 mm
Weight: 11.3 g, unit: 500 pcs.

Type: 84101 system 153

Ref. No.: 529832

Foot gaskets for systems 153

Weight: 0.5/0.7/0.7 g

Unit: 1000 pcs.

Type: 98002 degree of protection IP67

Ref. No.: 108947 material: PE foam

Type: 98087 degree of protection IP67

Ref. No.: 503773 material: EPDM, black

Type: 98003 degree of protection IP54

Ref. No.: 108266 material: EPDM, black

G5 push-fit lampholder

Casing: PC, white, interior part: PBT GF T140, nominal rating: 2/500

Push-in twin terminals: 0.5–1 mm²

Push-fit foot for wall thickness: 1.4–2 mm

Weight: 12.7 g, unit: 250 pcs.

Type: 84108 system 151

Ref. No.: 534073

Foot gaskets for system 151

Weight: 1/1.1/1.1 g

Unit: 1000 pcs.

Type: 98004 degree of protection IP65

Ref. No.: 108267 material: cellular rubber, black

Type: 98011 degree of protection IP67

Ref. No.: 504078 material: silicone, transparent

Type: 98008 degree of protection IP67

Ref. No.: 546254 profiled foot gasket, material: EPDM, black

Pin support for reliable contact

With spring adjustment

Max. permitted temperature T_m on the rear side of the lampholder: 110 °C

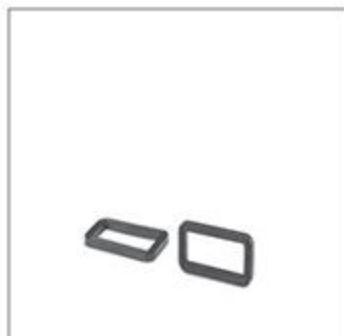
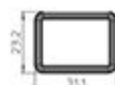
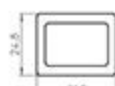
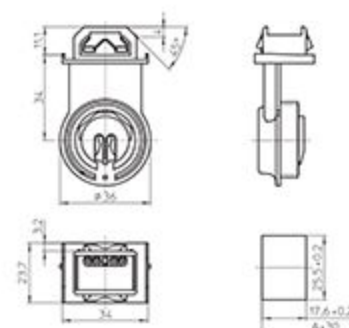
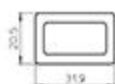
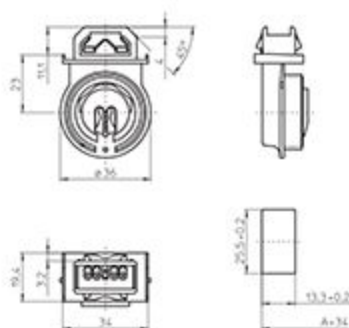

1

2

3

4

5

6

7

8

9

10

Screw ring for systems 151 and 153

Ring: PBT GF, white, gasket: silicone

Weight: 11.8 g, unit: 250 pcs.

Type: 84103

Ref. No.: 529836

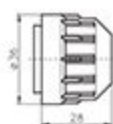

Lamp supports for lamps T-R5

For fluorescent lamps T-R5 (T-R16)

Lamp support for lamps \varnothing 16 mm

Material: PC, white, UV-stabilised

Fixing hole for screw M3

Fixing hole for self-tapping screw

acc. to ISO 1481/7049-ST4.2-C/F

Weight: 1 g, unit: 500 pcs.

Type: 84000

Ref. No.: 109532

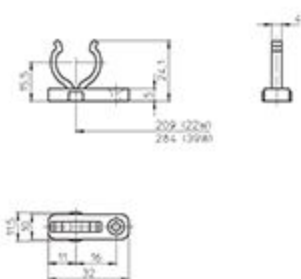

Lamp support for lamps \varnothing 16 mm

Material: PC, white, UV-stabilised

Push-fit foot for cut-out \varnothing 5.5 mm

Weight: 1 g, unit: 500 pcs.

Type: 84001

Ref. No.: 500757

